

Features:

- Compliant to ARINC 818 1.0625Gb/s and 3.1875Gb/s rates
- 850 nm VCSEL dual laser transmitter
- Class 1 Laser Int. Safety Std. IEC-825 compliant
- Standard reach of 500 m on 50/125 and 250 m on 62.5/125 μ m MMF
- High power VCSEL option for additional 4 dB of link budget
- 1x10 connector option
- Rugged LC connector housing including screw mounted OSAs
- MIL STD 883 certified
- -40 to +85 C operating temperature, wider options available
- *Option* for RoHS compliant and lead free per Directive 2002/95/EC
- Single +3.3V power supply
- TX AC-Coupled
- Low power dissipation
- Conformal coated for harsh environment use



The RJ-3G-TX2 is ideal for harsh environment connectivity because of its low cost, availability, and wide operating parameters



Commercial Aerospace



Military Aerospace



Military Tactical



Industrial Oil & Gas



Military Sensing



Undersea Networking

Absolute Maximum Ratings

Parameter	Symbol	Min.	Max.	Unit	Note
Maximum Supply Voltage	V_{CC}	-0.3	4.0	V	
Storage Temperature	T_{sto}	-55	100	°C	
Case Operating Temperature	T_{OP}	-40	85	°C	
Relative Humidity	RH	0	95	%	Based on conformal coating
Selective Soldering Temperature			260	°C	10 seconds, leads only (2,3)
Hand Lead Soldering Temperature			260	°C	10 seconds, leads only (2,3)
Conformal Coating		0.8	1.2	mil	See ruggedization notes

NOTES:

- 1) RJ transceivers may be water washed. The process must be followed by an 80°C bake for one hour to ensure the drying of any water inside the shell.
- 2) Solder Posts do not transmit data and do not need a complete solder fill.
- 3) The components should not undergo Wave Soldering under any circumstances.

General Specifications

Parameter	Symbol	Min.	Typ.	Max.	Unit	Notes
Data Rate	BR		3.1875		Gb/s	ARINC 818

Electrical Specifications ($T_{OP} = -40$ to $85^{\circ}C$, $V_{CC} = 3.135$ to 3.465 Volts)

Parameter	Symbol	Min.	Typ.	Max.	Unit	Notes
Supply Voltage	V_{CC}	3.135		3.465	V	
Total Module Power Dissipation	P_{DISS}		0.60	0.80	W	
Transmitter						
Supply Current	I_{CC}		85	120	mA	
Input differential impedance	R_{in}		100		Ω	
Input Signal Amplitude	V_{in}	0.5		2.4	V	AC Coupled Differential Input
Transmit Disable Voltage	V_D	2.0		V_{CC}	V	LVTTTL
Transmit Enable Voltage	V_{EN}	V_{EE}		0.8	V	LVTTTL

Pin Configuration

PIN #	Symbol	Description	Logic/Protocol
1	TD1+	Transmitter 1 DATA In +	LVPECL
2	V_{EE1}	Transmitter 1 Signal Ground	N/A
3	TD1-	Transmitter 1 DATA In -	LVPECL
4	V_{CC1}	Transmitter 1 Power Supply	N/A
5	T_{DIS2}	Transmit 2 Disable input Logic 1 = Disable Optical Output Logic 0 = Enable Optical Output Internal 4.7K ohm pull-down (enable)	LVTTTL
6	T_{DIS1}	Transmit 1 Disable input Logic 1 = Disable Optical Output Logic 0 = Enable Optical Output Internal 4.7K ohm pull-down (enable)	LVTTTL
7	TD2+	Transmitter 2 DATA In +	LVPECL
8	V_{CC2}	Transmitter 2 Power Supply	N/A
9	TD2-	Transmitter 2 DATA In -	LVPECL
10	V_{EE2}	Transmitter 2 Signal Ground	N/A

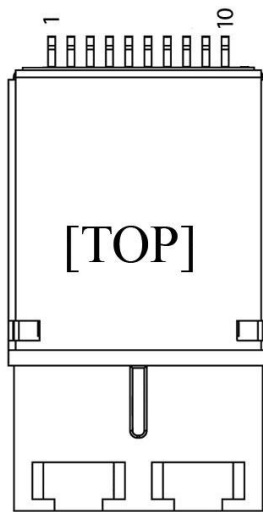

Optical Characteristics (T_{OP} = -40 to 85°C, V_{CC} = 3.135 to 3.465 Volts)

Parameter	Symbol	Min.	Typ.	Max.	Unit	Notes
Transmitter						
Output Optical Power (Standard)	P _{OUT}	-9		-3	dBm	(1)
Output Optical Power (High Power)	P _{OUT}	-5		-1	dBm	(1)
Optical Wavelength	λ	830	850	860	nm	
Spectral Width	σ			.85	nm	
Optical Rise/Fall Time	t _r /t _f			150	ps	(3)
Relative Intensity Noise	RIN			-117	dB/Hz	
Total Jitter Contribution (p-p)	TXΔTJ	Δ		85	ps	(4)

NOTES:

- 1) Class 1 Laser Safety per FDA/CDRH, EN (IEC) 60825 used on 50/62.5 MMF
- 2) Equivalent extinction ratio specification for Fibre Channel. Allows smaller ER at higher average power
- 3) Unfiltered, 20-80%. For Fibre Channel data rates, complies with FC 1x and 2x eye mask when filtered
- 4) If measured with TJ-free data input signal. In actual application, output TJ will be given by:

$$TJ_{OUT} = DJ_{IN} + \Delta DJ + \sqrt{(TJ_{IN} - DJ_{IN})^2 + (\Delta TJ - \Delta DJ)^2}$$
- 5) FC-PI-2-10.0 conformance, PRBS 2⁷-1 at 10⁻¹²

Equivalent Circuits

1. Equivalent Input Circuit

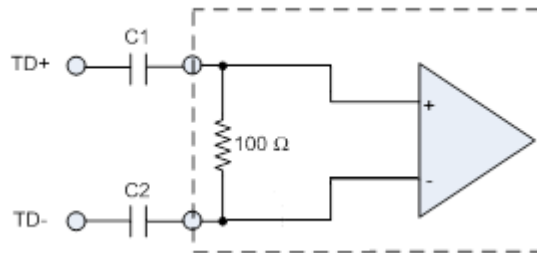

*Drawing shows entire RJ device and dotted line represents laser driver.
RJ-3G-TX2 is internally AC coupled.*

PCB Design Guidelines

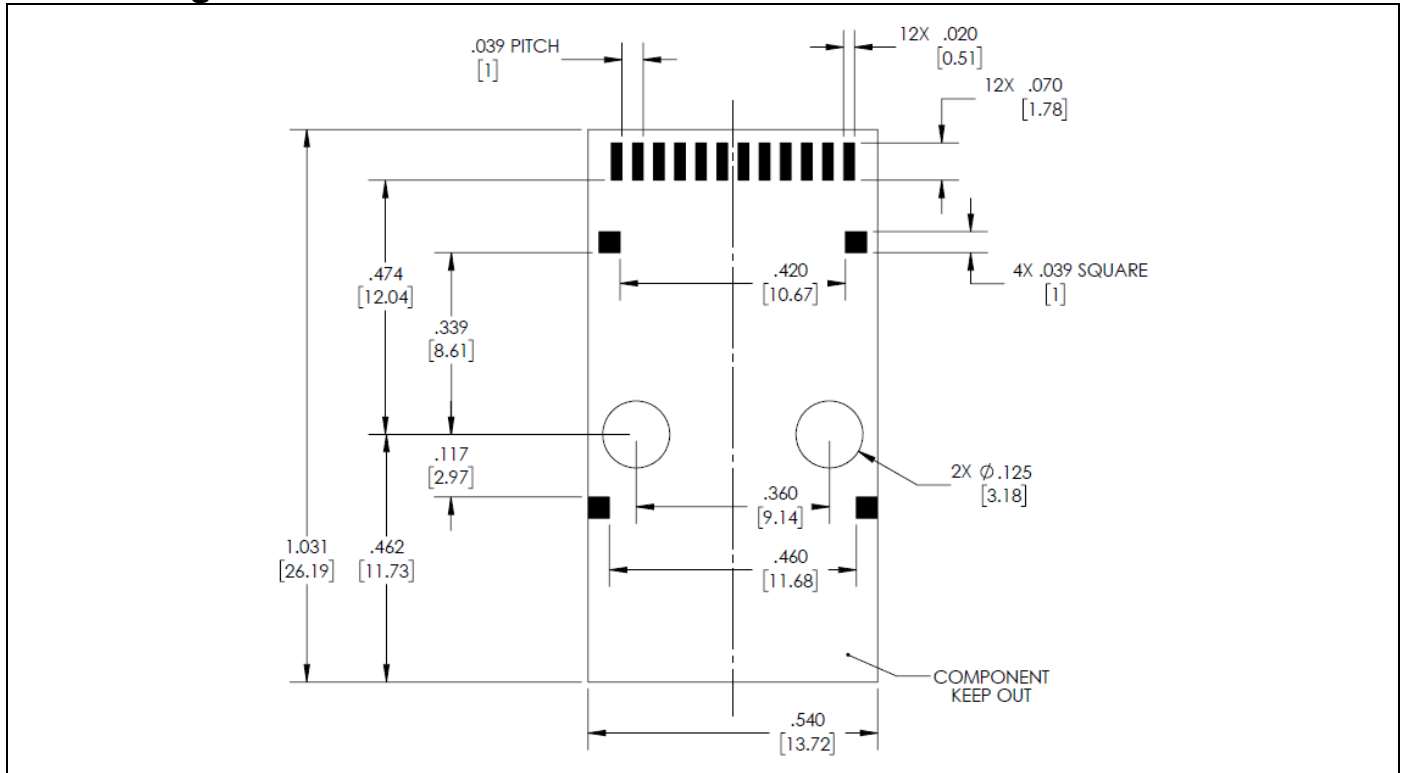

Panel Cutout

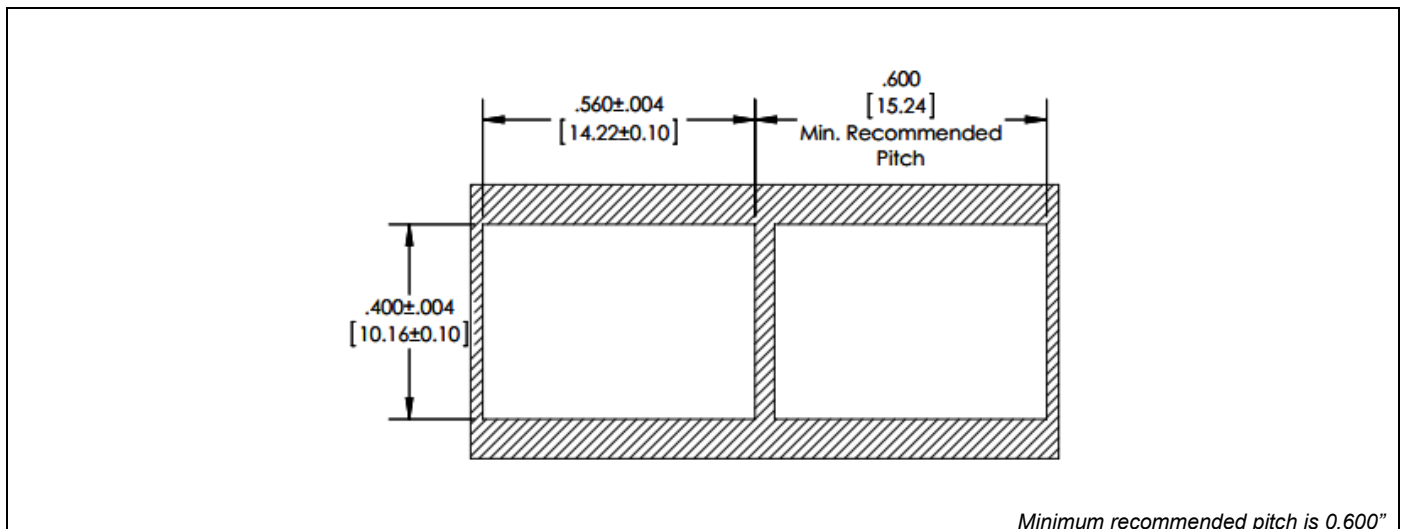

Screw Post Mechanical Dimensions

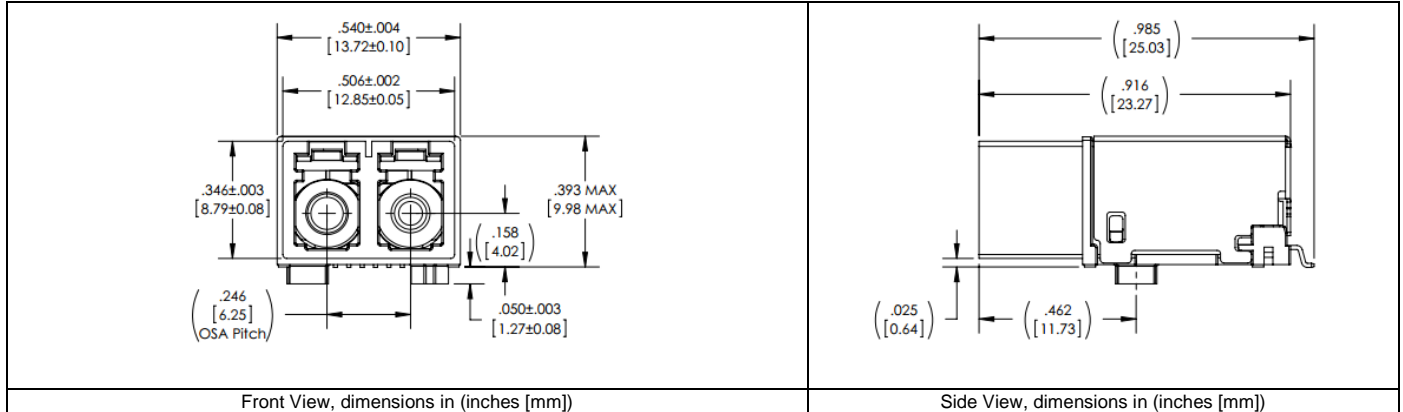

Optional Solder Post and Optional EMI Shield Mechanical Dimensions

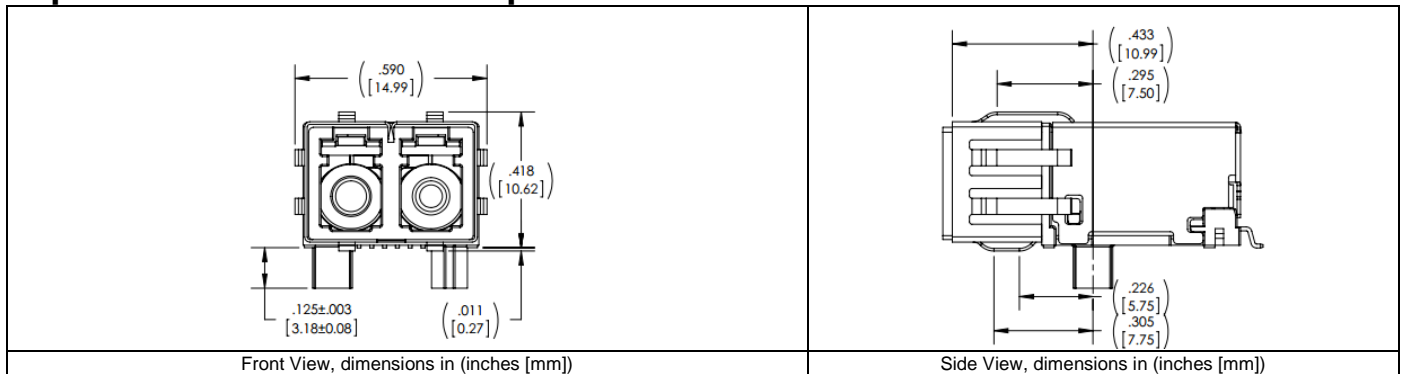

Mounting Hardware Guidelines

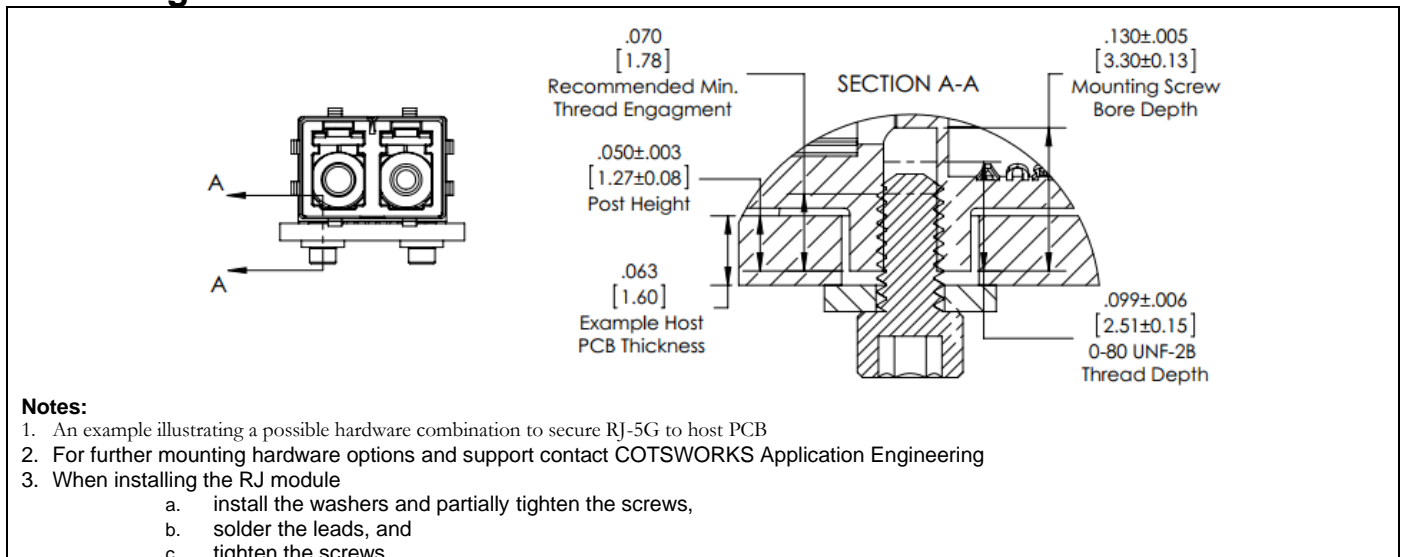

Ruggedization Notes

- Parylene C coating can be used for conformal coating with a 1.0 mil \pm 0.2 mil thickness through a deposition process. Parylene Type C has a 5600 VPM rating, withstands temperatures of 350°F, and is extremely resistant to oil/dirt, and object impact.
- Another option for conformal coating is Cytec Conathane® CE1155 is applied as a 1.5 mil film, which meets MIL-I-46058-C. It has resistance to moisture and abrasion. It is clear with a UV additive and has a 3000 VPM rating.
- This part can come in a pigtail fiber optic version.
- Contact COTSWORKS for all MSDS and case composition.
- An optional label or coating may be applied to prevent damage to the label during a chlorine wash.

Reference Information

- 1) IEEE Standard 802.3, 2002 Edition, 1000BASE-X. IEEE Standards Department, 2002
- 2) "Fibre Channel Draft Physical Interface Specification (FC-PI-2 Rev. 10.0)". American National Standard for Information Systems
- 3) Infiniband 1.2.1 specification, www.infinibandta.org
- 4) 3.125 Gb/s XAUI specification, IEEE 802.3ae, section 47
- 5) ARINC 818 specification at 3.1875Gb/s, <https://www.arinc818.com/>
- 6) Directive 2002/95/EC of the European Council Parliament and of the Council, "on the restriction of the use of certain hazardous substances in electrical and electronic equipment." January 27, 2003

Regulatory Compliance

- COTSWORKS transceivers are Class 1 Laser Products and comply with US FDA regulations.
- These products are compliant with TÜV and CSA Class 1 eye safety requirements of EN (IEC) 60825 and the electrical safety requirements of EN (IEC) 60950.
- This part has an option for compliance with Directive 2002/95/EC covering restriction on certain hazardous substances (RoHS). It invokes item 5 of the Annex which allows "Pb in the glass of cathode ray tubes, electronic components, and fluorescent tubes." This part may contain Pb for components such as lenses, windows, isolators, and other electronic components

Warnings:

Handling Precautions: This device is susceptible to damage as a result of electrostatic discharge (ESD). A static free environment is highly recommended.

Laser Safety: Radiation emitted by laser devices can be dangerous to human eyes. Avoid eye exposure to direct or indirect radiation.



Ordering Information

RJ-3G-TX2	()	-xx-	x	-x-	x	-x-	x
RJ Form Factor	Output Power	Connector	Ruggedized Coating	Operating Temp Range	EMI Shield	RoHS Level	Mounting
3Gbps Max Data Rate	(): -9 to -3 dBm	LC	(): Non-coated	A: -40 to 85°C	(): No Shield	(): Lvl 5	(): Imperial
Dual 850nm Transmitters	HP: -1 to -5 dBm		R: Parylene	M: -40 to 95°C	E: Shield	6: Lvl 6	U: Metric P: Solder Posts

Example part number: RJ-3G-TX2HP-LC-R-M

[3G RJ Form Factor Dual Transmitter, 850nm, high-power option, dual LC connectors, Parylene-coated, military operating temp. range]
COTSWORKS and the COTSWORKS logo are registered trademarks of COTSWORKS, LLC.

COTSWORKS reserves the right to change, alter, or revise this document without notice unless otherwise agreed to.

Contact COTSWORKS for mechanical dimensional information and other configuration options.